

# MIC0506DA

GaAs MMIC, Driver Amplifier, 0.1 – 4.0 GHz

v03.20



## Features

- ✓ Wide band: 0.1÷4.0 GHz
- ✓ Detector output power: Yes
- ✓ Gain: 20 dB
- ✓ Noise figure: 2 dB
- ✓ Die Size: 1.24x0.93x0.1 mm

## Die Device Layout

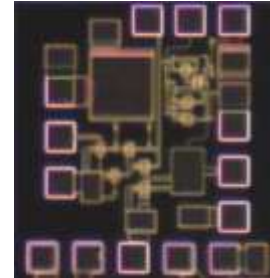

## General Description

MIC0506DA is a microwave driver amplifier die and it made by the 0.5  $\mu\text{m}$  length of GaAs PHEMT technology process. The die is grounded by through back metal hole.

## Application

- ✓ Microwave Radio & VSAT
- ✓ Weather radars
- ✓ Point-to-Point Radio
- ✓ Ultra wide band SAT Military & Space
- ✓ Wireless infrastructure
- ✓ Mobile radio
- ✓ Cellular/4G infrastructure

## Electrical Specification

Test condition unless otherwise notes: calculated data

Parameter	Typ.	Units
Frequency Range ( $\Delta f$ )	0.1÷1.0	GHz
Small Signal Gain ( $S_{21}$ )	10.5	dB
Gain Flatness ( $\Delta S_{21}$ )	$\pm 0.19$	dB
Noise Figure @	TBD	dB
Intermodulation Distortion	TBD	dBm
Output IP3 @	TBD	dBm
Output Power for 1 dB Compression ( $P_{1dB}$ )	3.5	dBm
Reverse Isolation ( $S_{12}$ )	TBD	dB
Input Voltage Standing Wave Ratio (VSWR in)	2	-
Output Voltage Standing Wave Ratio (VSWR out)	2	-
Drain Bias Voltage 1 ( $V_{D1}$ )	+6	V
Drain Bias Voltage 2 ( $V_{D2}$ )	-6	V
Supply Current 1 ( $I_{D1}$ )	22	mA
Supply Current 2 ( $I_{D2}$ )	22	mA

# MIC0506DA

GaAs MMIC, Driver Amplifier, 0.1 – 4.0 GHz

v03.20



## Driver Amplifier (calculated data)

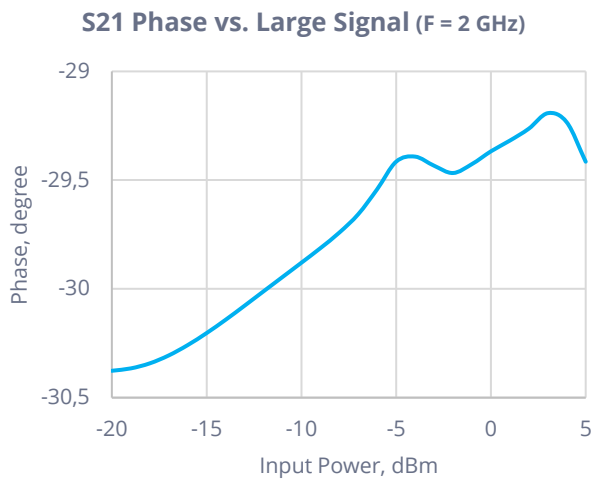
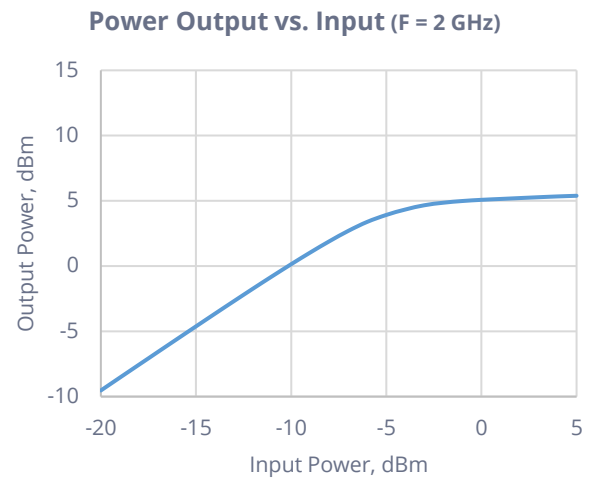
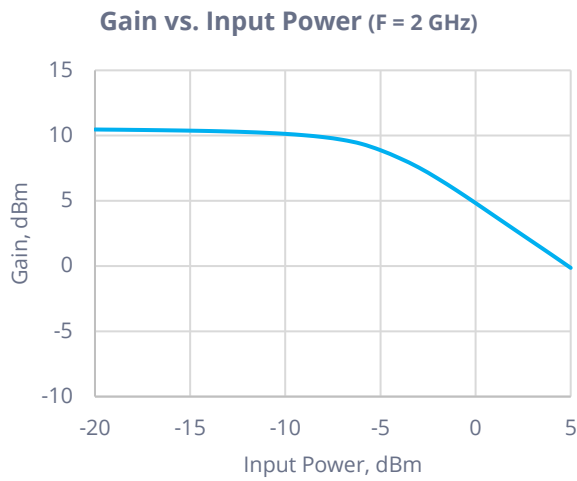
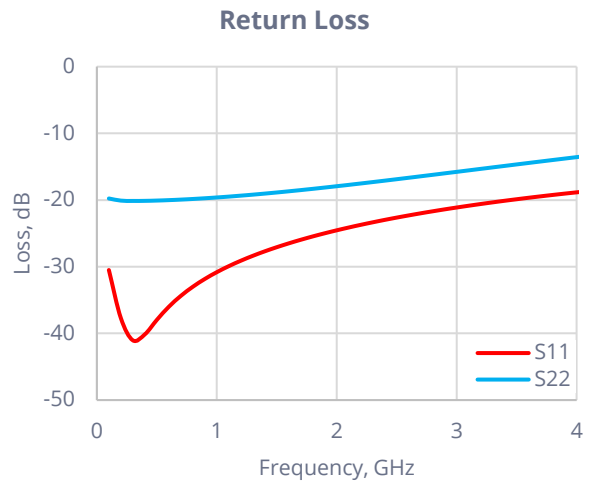
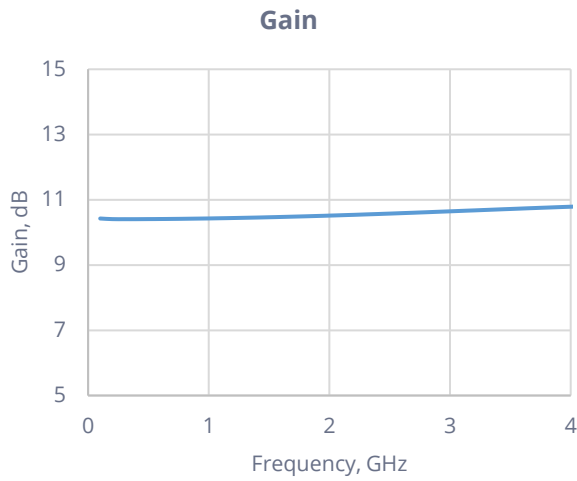

# MIC0506DA

GaAs MMIC, Driver Amplifier, 0.1 – 4.0 GHz

v03.20



## Absolute Maximum Ratings

Parameter	Absolute Maximum	Unit
Gate Voltage ( $V_g$ )	+7	V
Input Power ( $P_{in}$ )	+20	dBm
Storage Temperature	-70 to +95	°C
Operating Temperature	-60 to +85	°C
Channel Temperature	+175	°C

# MIC0506DA

GaAs MMIC, Driver Amplifier, 0.1 – 4.0 GHz

v03.20



## Application Circuit

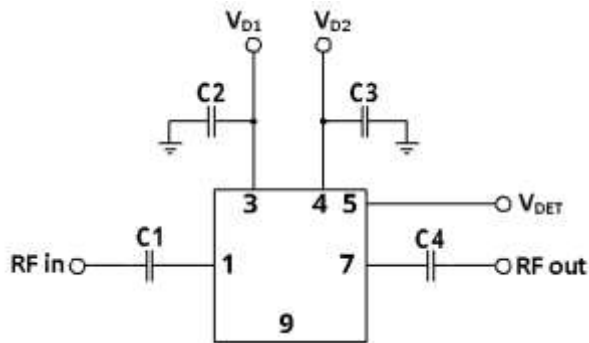

## Die Outline

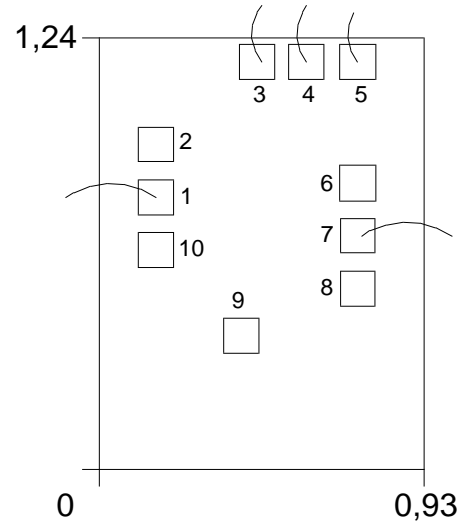

## Additional Components

Reference Designator	Components
C1, C4	Cap: 560 pF, GRM1885C1E561J
C2-3	Cap: 100 pF, 0.6x0.6 mm, K10-71

## Pad Diagram & Dimension (units in mm)

N	Function	Origin		Size	
		X	Y	X	Y
1	RF in	0.16	0.50	0.10	0.10
2	GND	0.16	0.65	0.10	0.10
3	V <sub>D1</sub>	0.45	0.88	0.10	0.10
4	V <sub>D2</sub>	0.59	0.88	0.10	0.10
5	V <sub>DET</sub>	0.74	0.88	0.10	0.10
6	GND	0.74	0.54	0.10	0.20
7	RF out	0.74	0.39	0.10	0.10
8	GND	0.74	0.24	0.10	0.10
9	N.U.	0.41	0.10	0.10	0.10
10	GND	0.16	0.35	0.10	0.10

# MIC0506DA

## GaAs MMIC, Driver Amplifier, 0.1 – 4.0 GHz

v03.20



### Handling and Assembly Information

**CAUTION!** - This MMIC Products contain gallium arsenide (GaAs) which can be hazardous to the human body and the environment. For safety, observe the following procedures:

- *Do not ingest.*
- *Do not alter the form of this product into a gas, powder, or liquid through burning, crushing, or chemical processing as these by-products are dangerous to the human body if inhaled, ingested, or swallowed.*
- *Observe government laws and company regulations when discarding this product. This product must be discarded in accordance with methods specified by applicable hazardous waste procedures.*

**Life Support Policy** - This product is not authorized for use as critical components in life support devices or systems. As used herein: (1) Life support devices or systems are devices or systems which, (a) are intended for surgical implant into the body, or (b) support or sustain life, and whose failure to perform when properly used in accordance with instructions for use provided in the labeling, can be reasonably expected to result in a significant injury to the user. (2) A critical component is any component of a life support device or system whose failure to perform can be reasonably expected to cause the failure of the life support device or system, or to affect its safety or effectiveness.



**ESD** - Gallium Arsenide (GaAs) devices are susceptible to electrostatic and mechanical damage. Die are supplied in antistatic containers, which should be opened in cleanroom conditions at an appropriately grounded antistatic workstation. Devices need careful handling using correctly designed collets, vacuum pickups or, with care, sharp tweezers.

**Die Attachment** - GaAs Products are 0.100 mm (0.004") thick and have vias through to the backside to enable grounding to the circuit. Microstrip substrates should be brought as close to the die as possible (<100um is good). The mounting surface should be clean and flat. If using conductive epoxy, recommended epoxies are Namics SK70N, Ablestick 84-1LMI or 84-1LMI cured in a nitrogen atmosphere per manufacturer's cure schedule. Apply epoxy sparingly to avoid getting any on to the top surface of the die. An epoxy fillet should be visible around the total die periphery. If eutectic mounting is preferred, then a fluxless gold-tin (AuSn) preform, approximately 0.001 thick, placed between the die and the attachment surface should be used. A die bonder that utilizes a heated collet and provides scrubbing action to ensure total wetting to prevent void formation in a nitrogen atmosphere is recommended.

**Wire Bonding** - Windows in the surface passivation above the bond pads are provided to allow wire bonding to the die's gold bond pads. The recommended wire bonding procedure uses 0.076 mm x 0.013 mm (0.003" x 0.0005") 99.99% pure gold ribbon with 0.5-2% elongation to minimize RF port bond inductance. Gold 0.025 mm (0.001") diameter wedge or ball bonds are acceptable for DC Bias connections. Aluminum wire should be avoided. Thermo-compression bonding is recommended though thermosonic bonding may be used providing the ultrasonic content of the bond is minimized. Bond force, time and ultrasonics are all critical parameters. Bonds should be made from the bond pads on the die to the package or substrate. All bonds should be as short as possible.